

**EUROPEAN
PRODUCT
GUIDE**



WORLDWIDE SITES



ASIA HQ Tokyo Japan, founded 1956
(Listed in the first section of the Tokyo Stock Exchange)
 Design Center: 1
 Sales Office: 11
 Manufacturing Site: 8 **20**

EMEA HQ Munich Germany, founded 1986
 Design Center: 2
 Sales Office: 5
 Manufacturing Site: 1 **8**

AMERICAS HQ San Jose CA. USA, founded 1983
 Design Center: 1
 Sales Office: 1
 Manufacturing Site: 1 **3**

MARKETS

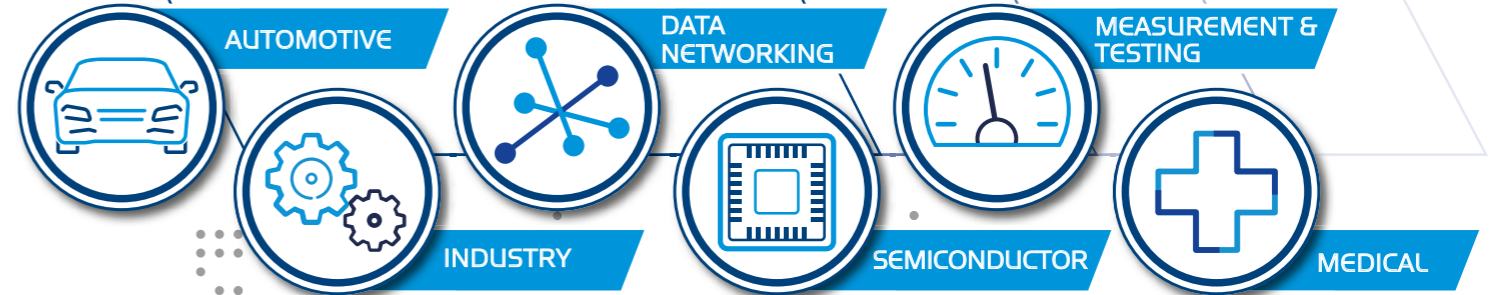

WORLDWIDE EMPLOYEES



GROUP 2,309 in production
 325 in engineering **3,280**

EMEA 130 in production
 110 in engineering **385**

ANNUAL SALES



GROUP 333 Mio. Euro

EUROPE 104.8 Mio. Euro

DIVISIONS

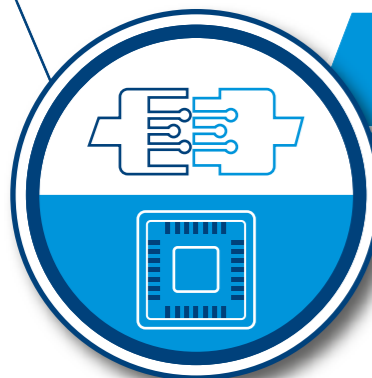

CONNECTOR SOLUTIONS
 Standard & customised connectors, cable assemblies

TEST SOLUTIONS
 Test & burn-in sockets, test contactors, module test adapters, PCB design

DESIGN CENTER

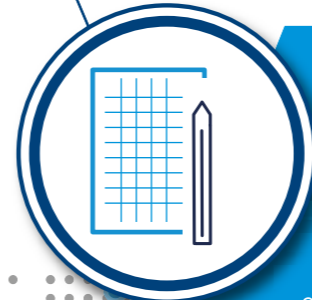

- Complex 3D CAD Construction
- Design FMEA
- Analysis using FEM
 - Structural Mechanics
 - Moldflow for Plastics
 - Thermal Simulation (Flow & Static)
 - Signal Integrity
- PCB Design
- Circuit Simulation
- High Resolution 3D Prototyping
 - Plastics (Photo Polymeric)
 - Metal (LMF Laser Metal Fusion)
- In-house Sample Construction

TEST LABORATORY



- High Voltage & High Current Testing
- High Frequency Measurements
- Soldering
- SEM (Scanning Electron Microscope)
- EDX (X-Ray spectroscopy)
- Computer Tomography / X-Ray
- X-Ray Fluorescence Spectrometer
- De-Rating

ENVIRONMENT

- Climatic & Temperature Chambers
- Mixed Gas (4 Gases) Testing
- Shock and Vibration Chamber
- Corrosion Tester
- IP Testing
- Bending-Rotation Tester

MANUFACTURING



In our production facility in Frankfurt (Oder) Germany, we manufacture connectors and cable assemblies as well as test contactors on 5,148 m².





Y-CIRC P - SERIES

With the Y-Circ P series, Yamaichi Electronics offers an optimised Push-Pull circular connector. The circular connector series was developed and qualified in Germany and is manufactured in our production facility in Frankfurt (Oder). This guarantees a short response time to the requirements of our European customers. The high level of vertical integration ensures the highest quality and short delivery times. The product portfolio also includes various accessories for the Y-Circ P circular connector series and for cable assemblies.



Use our CONFIGURATOR



YOUR ADVANTAGES

- Various connector sizes in IP50 and IP68
- The connectors are shorter than comparable commercially available models
- The patented half-shell design enables simple and error-free assembly
- Customised pin layouts and layouts for high data rates such as Cat6_A
- 100% Made in Germany

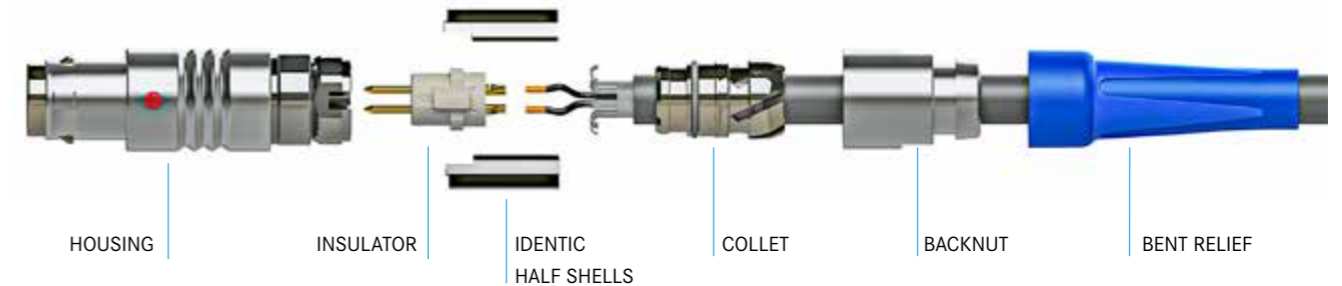

IP50: B-SERIES

- Mechanical coding via the housing
- Various coding options
- 5,000 mating cycles guaranteed

IP50: S-SERIES

- Mechanical coding via hermaphroditic insulators
- 5,000 mating cycles guaranteed



IP68: T-SERIES

- Mechanical coding via the housing
- Various coding options
- 5,000 mating cycles guaranteed
- Waterproof
- Patented one-piece collet



Y-CIRC P **10** Gbit/s
HIGH-SPEED
SPE

MORE INFORMATION ON PAGE 13



CABLE CONNECTORS: PLUGS



PB
Standard Backnut

B S T 09 12 15 18



PR
Backnut for Bend Relief

B S T 09 12 15 18



AB
Angled; Variable Cable Exit Direction
Standard Backnut

B S T 09 12 15 18



AR
Angled; Variable Cable Exit Direction
Backnut for Bend Relief

B S T 09 12 15 18

CABLE CONNECTORS: SOCKETS



SB
Standard Backnut

B S T 09 12 15 18



SR
Backnut for Bend Relief

B S T 09 12 15 18



Use our CONFIGURATOR

WALL MOUNTED CABLE CONNECTORS



WB
Standard Back Nut

B S T 09 12 15 18



WR
Back Nut for Bend Relief

B S T 09 12 15 18



WJ
Standard Back Nut

B S T 09 12 15 18



WK
Back Nut for Bend Relief

B S T 09 12 15 18

WALL MOUNTED CONNECTORS



WA
Front Mounting

B S T 09 12 15 18

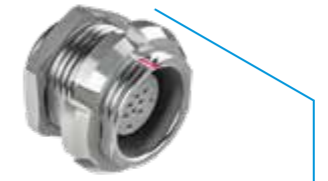

WC
Front and Backward Mounting

B S T 09 12 15 18



WD
Backward Mounting

B S T 09 12 15 18

WATER TIGHT WALL MOUNTED CONNECTORS



IA
Front Mounting

B S T 09 12 15 18



ID
Backward Mounting

B S T 09 12 15 18

Series		Sizes	
B	IP50	09	Ø 09mm
S	IP50 Hermaphrodit	12	Ø 12mm
T	IP68	15	Ø 15mm
		18	Ø 18mm
		■	Available
		■	Not Available

PCB MOUNTED CONNECTORS



WG
Thread and Front Nut

B S T 09 12 15 18



WH
Without Thread

B S T 09 12 15 18



WE
Angled, Thread and Front Nut

B S T 09 12 15 18



WI
Angled, without Thread

B S T 09 12 15 18



M12 CIRCULAR CONNECTOR Y-CIRC M

The Y-Circ M series comprises circular connectors with screw or Push-Pull locking in accordance with the M12 specification. The product portfolio includes the standardised variants from A-coded to high-speed X-coded CAT6_A. All variants are available as cable assemblies in different lengths and cable types.



Use our CONFIGURATOR



YOUR ADVANTAGES

- Developed and manufactured in Germany
- Protection class IP65 / IP67
- Push-Pull and screw locking available
- A, B, D, X and L codings available



M12 CIRCULAR CONNECTOR Y-CIRC M

- A, B, D coding according to IEC 61076-2-101
- Optional high-grade EMI protection with 360° shielding connection
- X-coding according to IEC 61076-2-109
- L-coding for power transmission in accordance with IEC 61076-2-111
- Vibration-proof locking
- Optionally with screw locking or Push-Pull locking according to IEC 61076-2-012



PUSH-PULL LOCKING SYSTEM ACC. TO IEC 61076-2-012

- Space and time saving
- Backwards compatible - The Push-Pull appliance box is suitable for both M12 Push-Pull connectors and conventional connectors with an M12 screw thread.
- Robust & secure - Long locking hooks engage deeply into the socket, ensuring maximum durability even under torsional loads. Correct locking is confirmed by a haptic and acoustic signal. Locks reliably even in areas that are difficult to access and where installation space is limited.
- IP65 / IP67 protected
- Coding A, B, D, X, L for reliable signal, data and power transmission
- In accordance with IEC 61076-2-012



In addition to easy unlocking in confined spaces, the unlocking aid also offers the option of colour coding.

WATCH THE VIDEO



FIELD ASSEMBLY M12 CONNECTOR 8X & 4D

- Quick and easy assembly - without tools
- Modular system for customer-specific adaptation of the connector

WATCH THE VIDEO



4D

- Industrial Ethernet
- Profinet
- Ethernet / IP
- EtherCat
- Max. 100Mbit



8X

- CAT6_A high-speed data transmission (up to 10Gbit/s)



INDUSTRIAL RJ45-SERIES Y-CON

The IP-protected, robust Y-Con system includes RJ45 connectors and cable assemblies. A unique feature of the series is the optional integration of 2 additional power contacts in the RJ45 mating face for the transmission of up to 3.1A. The system enables data rates of up to CAT6_A.



YOUR ADVANTAGES

- RJ45 plus optional power transmission up to 3.1A
- First-class products for protection against vibration, EMI and mechanical stress
- Up to 1,500 mating cycles
- Suitable for a wide temperature range from -40°C up to 120°C
- Selectable number of contacts for connectors 4, 6, 8, 10



Y-CON IP20

- IP20 lock for vibration-proof RJ45 connections
- Increased EMI protection through additional product features
- Optional power contacts

Y-CON PROFIX CAT6_A CONNECTOR

- Tool-free mounting
- Optional additional power contacts up to 3.1A @ 70°C
- Transfer rates up to 10 Gbit

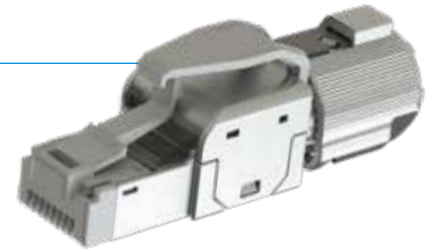

Y-CON IP67/68/69K

- Push-Pull locking mechanism
- Metal cover for high mechanical stability
- Special locking system for vibration-proof RJ45 connections
- Increased EMI protection through additional product features
- Protection class IP67/68 /69K
- Optional power contacts



PLUGS AND JACKS

- Optional power contacts with up to 3.1A @ 70°C
- Optional magnets
- Optional light pipes for reflow solderings
- Transfer rates up to 10Gbit
- Number of contacts selectable depending on application



COUPLERS FOR ELECTRICAL CABINETS RJ45 TO M12

With the new couplers for electrical cabinets, you can easily switch from internal RJ45 control cabinet cabling (IP20) to an outer cabling in M12 (IP67). Different coding variants (A8, D4 and X coding) ensure adaptation to the required transmission performance and, with the A8, offer the option of additional power transmission.





Y-SPE – INDUSTRIAL SINGLE PAIR ETHERNET

Single Pair Ethernet (SPE) is a future-oriented communication platform for electrical and electronic components and machinery and the industry's key to efficient and cost-effective data transmission from sensor to cloud. The use of two contacts instead of the previous four or eight reduces costs, saves space, weight and time during installation.

The mating faces are according to IEC standards, which are already released or in preparation.

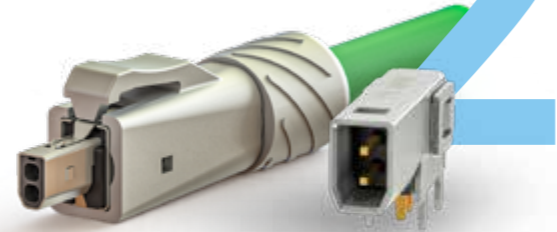

Mating faces according to IEC 63171-2
Connectors according to IEC 63171-5 /-6 /-7



YOUR ADVANTAGES

- Transmission lengths of up to 1,000m and transmission rates of up to 10Gbit/s
- Additional power transmission of up to 50W via Power over Data Line (PoDL) possible
- Mating faces of sub-standards IEC 63171-2 /-5 /-6 /-7 with IP20 or IP6X solutions available
- M12-based connectors with screw or Push-Pull locking
- Push-Pull locking (according to IEC 61076-2-012)



Y-HDE - SPE FOR AUTOMOTIVE

With the Y-HDE series, Yamaichi Electronics offers differential high-speed connectors that provide high-speed data transmission for the automotive sector in the smallest installation space. With transmission rates of up to 20Gbps at 100Ohm differential impedance and tested in accordance to LV214/USCAR, the Y-HDE is convincing in many high-speed applications.

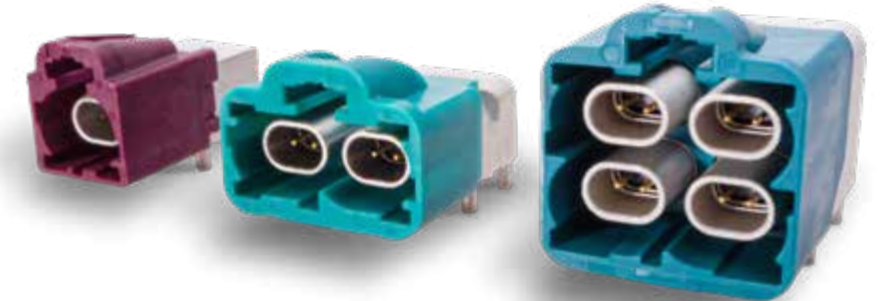

YOUR ADVANTAGES

- High-speed Data Ethernet developed and tested for automotive requirements
- Data transmission up to 15Ghz/20Gbps
- 100Ohm differential impedance
- 7 different codings of the single-type version
- Mechanical and color coding
- Space and weight saving design
- Single, double and quad versions



Y-CIRC P - PUSH-PULL FOR SPE

In addition to numerous other high-speed connectors, Yamaichi also offers high-speed solutions for the Y-Circ P product group. In our in-house laboratory, we can develop and simulate pin layouts for high-speed applications. The S1 pin layout enables the transmission of Single Pair Ethernet up to 10 Gbit/s according to IEC 802.3ch and automotive Ethernet signals according to Open Alliance Standard TC9.

YOUR ADVANTAGES

- Transmission of Single Pair Ethernet up to 10Gbit/s according to IEC 802.3ch
- Innovative, patent-pending insulator and contact design
- Reliable Push-Pull mechanism
- Min. 5,000 mating cycles





CABLE ASSEMBLIES

Yamaichi Electronics is the only cable assembly provider to offer its own Y-Circ M (M12), Y-Circ P (Push-Pull), RJ45 and USB connectors from a single source. This bundling of connector production and cable assembly at one production site guarantees short response times and the rapid realisation of customer inquiries.

For this, a comprehensive production location has been established in Frankfurt (Oder). It includes overmoulding and hot-melt machines, fully automated stripping and cutting machines as well as turning and milling capabilities. Assemblies with bought-in components are also possible.

Y-Circ P



Y-Con



Y-Circ M



Y-FFC - FLEXIBLE FLAT CABLES

In order to complete the product family of various FFC connectors, Yamaichi Electronics offers Flexible Flat Cables (FFC) from its own production site in Frankfurt (Oder) - i.e. „FFC Made in Germany“. The FFCs are produced using state-of-the-art production facilities and fulfill the automotive standards.

YOUR ADVANTAGES

- Pin count up to 200
- Different pitches, e.g. 0.5mm, 1mm or 2mm spacing
- Different pitches and conductor widths possible (e.g. for mixing power and signal contacts)
- Different mating shapes of both side of FFC
- Shielding via shielding tapes available

Yamaichi offers FFCs for their own connector series like Y-Lock or HF601, but also any kind of customised FFCs.



The FFC-production line in Frankfurt (Oder)



Y-LOCK PULLFORCE

The Y-Lock connector series is combining a space saving and process securing design with intelligent and reliable technology. The connector system is designed for applications with high requirements. Available in three different versions, Y-Lock can fulfill a large spectrum of requirements regarding mechanical, climatic and electrical specifications. The Y-Lock system has been qualified based on LV214 and is fully suitable for automotive use.

Y-LOCK VERSION 1

Locking function between the supporting tape on the FFC and the connector. Small hooks on the inner housing of the connector insulator on the connector provide the locking function between the FFC and the connector.

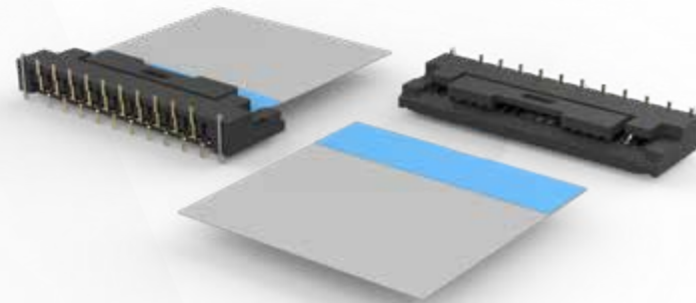

Y-LOCK VERSION 2

Additional stiffener is assembled mechanically on the FFC. Locking function between stiffener and connector. The Poka Yoke system prevents the FFC from being inserted incorrectly. The stiffener provides a guiding aid when inserting the FFC.

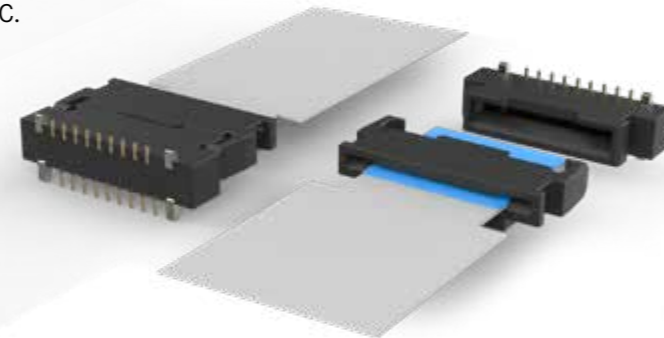

Y-LOCK VERSION 3

Same as version 2, but with double locking function based on front and side hooks.

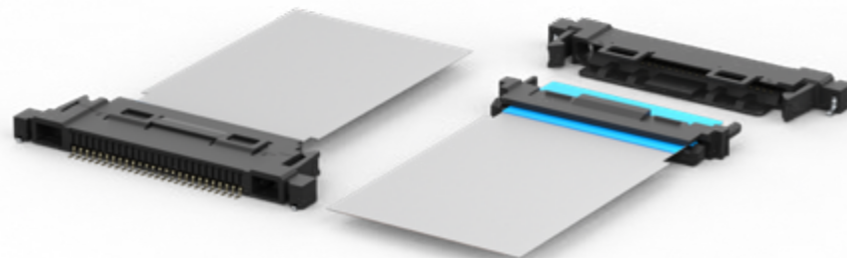

WATCH THE VIDEO



YOUR ADVANTAGES

- Non-ZIF Board-to-Cable System
- FFC only needs to be pressed into the lock (One-Push-Lock) and can be easily pulled out again (Pullforce)
- Quick and easy assembly
- Poka-Yoke system
- Different numbers of pin counts available
- Automatic assembly of FFC possible
- Qualified based on LV214



SPECIAL BOARD-TO-BOARD CONNECTORS

The Board Edge Connector series BEC is following the standard for MXM 1.0 and QSeven applications. The special contact shape ensures mechanical stability at all vibration and shock conditions. This connector series is also available as a high-speed version with a transmission rate of up to 5Gbps. Yamaichi also offers a solution for the next MXM generation 3.1. This BEC series is complemented by a power connector. Furthermore, this product group includes a floating Board-to-Board connector. The HF301 series combines a floating function in X, Y and Z directions as well as mechanical stability and a transfer rate of 8Gbps and additional power pins.

YOUR ADVANTAGES

- The BEC and HF301 series has been developed and tested based on automotive specifications
- Special contact designs ensure a long life stability during shock, vibration and harsh environmental conditions
- All connectors are manufactured in IATF 16949 certified factories



ZIF CONNECTOR SERIES

The ZIF connector Series HF601 is usable for FFC and FPC. For improved retention force function ears can optionally be used. The special cover design allows a real "click feeling". The contact design allows a transfer rate of 1Gbps. With up to 3Gbps, a special HDMI version is available. The series is available in wide range of pin counts and 90° / 180° version. FFC's can be supplied from Yamaichi as well.

YOUR ADVANTAGES

- The HF601 series was developed and tested based on automotive specifications
- Special contact designs ensure long live stability during shock, vibration and harsh environmental conditions
- All connectors are manufactured in IATF 16949 certified factories



HIGH-SPEED BOARD-TO-CABLE SERIE

Yamaichi offers various high-speed board connectors with matching high-speed cable systems. All connector series are Non-ZIF connectors which are locking with the cables directly or via an additional adapter. This ensures a perfect mating and locking function. The connector series is providing different pin counts, directions and sizes. All connectors comply with the impedance specification of 100Ohm and can reach up to 10Gbps with the appropriate cable.

YOUR ADVANTAGES

- HF507 series for LVDS applications with 21, 31, 41 and 51 pins
- HF509 series for IEEE applications with 10 pins
- HF513 series, the smallest and fastest connector with 30, 40 and 50 pins

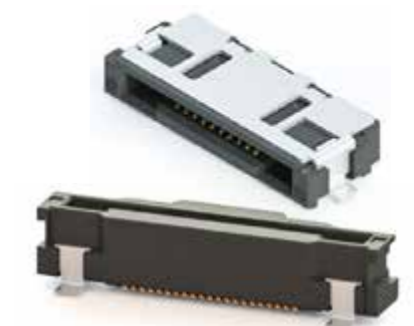



YFLEX FLEXIBLE PRINTED CIRCUIT

YFLEX is a special high-speed FPC (Flexible Printed Circuit) which is able to transmit up to 112 Gbps with a differential impedance of 100Ohm. This high performance is given by different features such as LCP as base material, the contacting of different layers done by silver bumps and the special production process.

This makes the YFLEX the perfect partner for our high-speed connector series like HF513, HF509, HF601 and HF507. Each YFLEX will be designed based on the customer's specific requirements so that all parameters such as pinning, number of layers and routing can be customised.

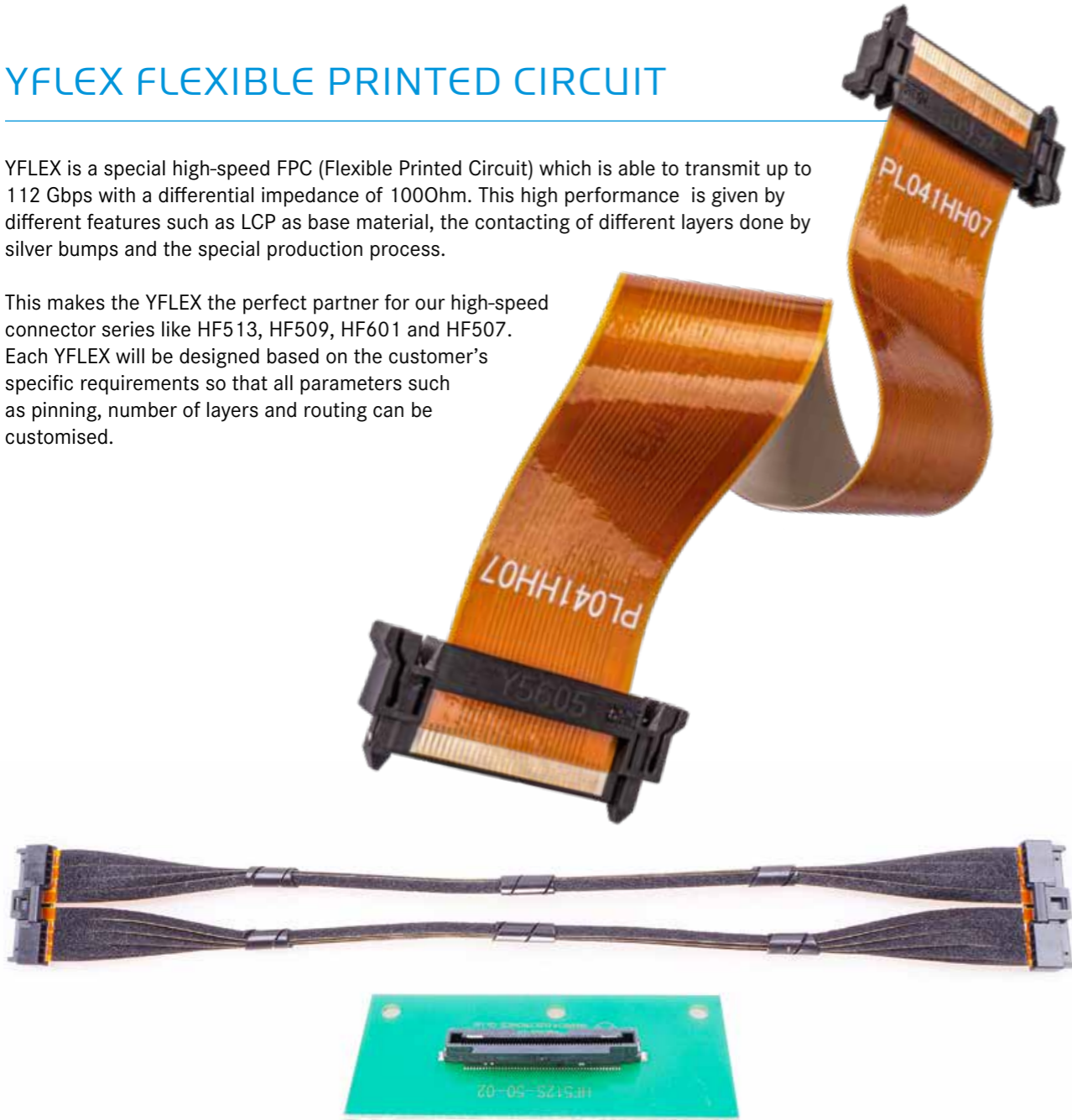

YOUR ADVANTAGES

- Transmission rate 56Gbps-PAM4
- Suitable Yamaichi Non-ZIF connectors (HFx series) available
- Lower skew compared to coax or twinax cables or twinax cables Low loss material (up to 460mm length)
- Low crosstalk design for bidirectional transmission

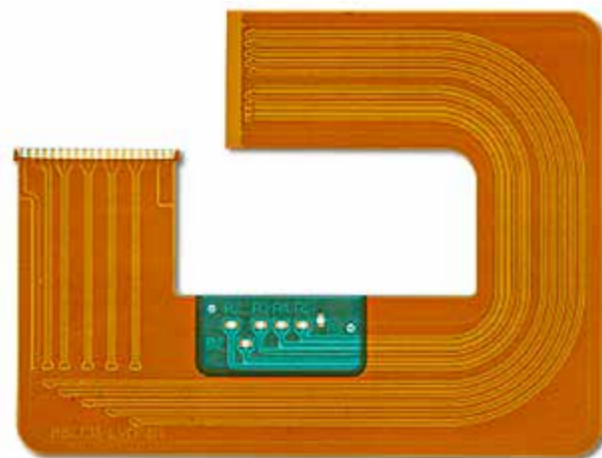

BURN-IN BACKPLANE CONNECTOR

Burn-in backplane connectors are used for the connection of burn-in oven. The typical test temperature is 150°C for several hours.

YOUR ADVANTAGES

- 432 pins (signal 200 pins, GND 200 pins, power supply 32 pins)
- High temperature: - 40°C up to +180°C
- 90°C orientation
- Low insertion force
- Robust design
- Supports high channel parallelism requirements



HIGH-SPEED MEZZANINE CONNECTOR

The YTM series combines maximum density with total modularity and 112G-PAM4 data rate. The modular concept allows the widest range of pin count and stacking height variations.

YOUR ADVANTAGES

- 112Gbps-PAM4 on all differential pairs
- Mating height with plug and socket: 5mm to 10mm in 1mm increments
- Height extension by interposer: 11mm up to max. 40mm
- Genderless design with two-point contacts for better connectivity
- Various pin counts: 192, 288, 384 up to 960 pins
- Differential signal pairs up to 240 pairs (GSSG)

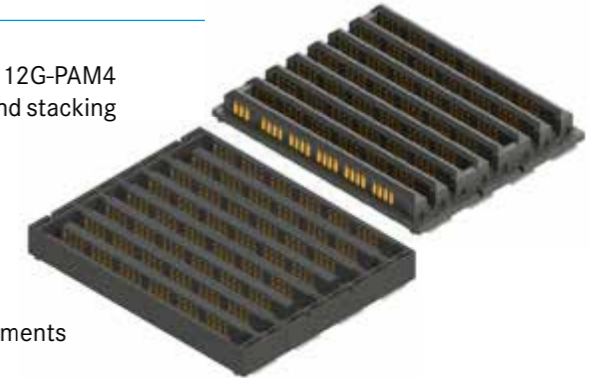

FLEXIBLE BOARD-TO-BOARD JUMPER

The Flexible B-to-B Jumper offers the possibility of stepless bending far beyond a 90° angle. This allows the connection of Printed Circuit Boards in almost any desired angle. Thanks to the heat-resistant Kapton film, the Flexible B-t-B Jumper can be easily integrated into the reflow and SMT soldering process.

YOUR ADVANTAGES

- Customised materials, coatings and pin counts
- Possibility of „dense“ assembly on the PCB
- Cost-effective to implement and an alternative to rigid-flexible PCBs
- Tape & Reel Packaging makes it possible for the flexible B-to-B Jumper to be easily integrated into the production even with a high degree of automation

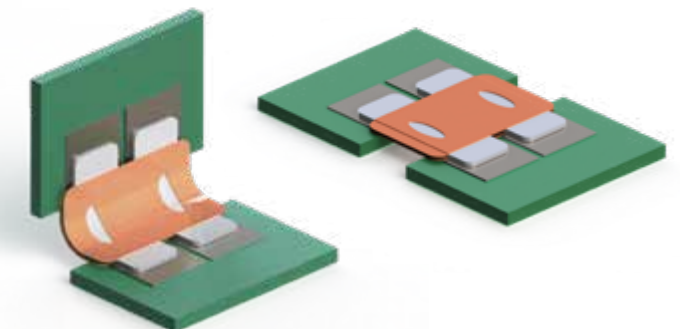



PLUGGABLE MODULE CONNECTORS

PLUGGABLE MODULE CONNECTORS

Yamaichi Electronics is the leading company for 112G high-speed connectors. Our portfolio includes benchmark breaking signal integrity connectors up to 112G-NRZ and is compatible for pluggable module connectors of the CFPx, (Q)SFP and OSFP family. This also includes 112G Mezzanine and YFLEX - our flexible high-end-PCB (FPC).

Yamaichi Electronics plays a leading role in 112G standardisation and has provided many leading concepts for MSAs, IEEE, OIF and PICMG.

112GBPS JUMPER CABLE

As requirements for data transmission speed are reaching the upper limit of existing printed circuit board (PCB) technologies, it is becoming more difficult to realise constant and reliable data transmission performance. To solve this problem, Yamaichi has developed a jumper cable connector system, that provides stable data transmission with 112Gbps PAM4 signals.

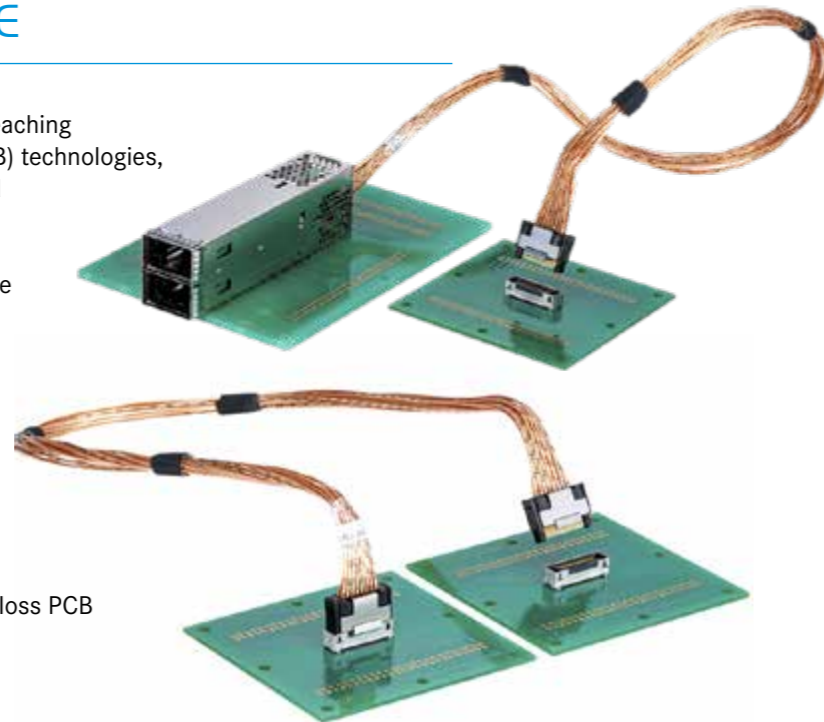

YOUR ADVANTAGES

- Extended signal reach by low loss cable vs. high loss PCB
- Simplifies the design of high-speed PCBs
- Reduces PCB material requirements

CFP X CONNECTOR

Yamaichi Electronics sets the standard for CFPx. We have developed the leading design for CFP2, CFP4 and CFP8. We continue to expand our successful product series by realising market-leading innovations for CFP2 112G-PAM4 with a current capacity of 2.2 A and more. CFPx is ready for the next generation of ACO and DCO modules.

YOUR ADVANTAGES

- Up to 112G PAM4/64G-NRZ/56G-NRZ per differential pair
- Current capacity up to 2.2A for the latest generation of DCO
- Host connector, plug and mechanical sets available
- Customised cages and heat sinks with heat pipes for better heat dissipation or smaller dimensions
- Supports Belly-to-Belly Mount design
- Single and Dual-Port designs



PLUGGABLE MODULE CONNECTORS

OSFP CONNECTOR

Yamaichi OSFP connectors support data rates of up to 800Gbps per port and 112G-PAM4 per differential pair. OSFP has an integrated heat sink improving thermal performance.

YOUR ADVANTAGES

- OSFP MSA compliant
- 1x4, 2x1 and 2x4 cage configurations
- Up to 8 x 112G-PAM4 per differential pair and 800GbE per slot
- Also 2x1 SMT stack type up to 112G



QSFP | QSFP-DD CONNECTOR

Upgrade your QSFP interface to 112G-NRZ. Yamaichi launched the first 56G-NRZ/112G-PAM4 QSFP-Host connector supporting up to 400Gbps per port.

YOUR ADVANTAGES

- For style A (SFF-8662) and style B (SFF-8672)
- Up to 56G-NRZ or 112G-PAM4 per differential pair
- Large variety of style A & style B cages and heat sink heights
- Widely applied for 100/200/400GbE & InfiniBand EDR/FDR/QDR/HDR
- 1x1, 1x4, 2x1 and 2x6 cage configurations
- Fin and Pin type heat sinks available
- Wafer technology outperforming the market
- Enables significantly higher power ratings per module than MSA spec



SFP | DSFP/NGSFP | NGSFP-DD CONNECTOR

SFP28 host connector for a data transfer rate of 56Gbps PAM-4 modulation per one channel. The DSFP MSA has chosen Yamaichi's proposal as the leading design. Double data rate compared with SFP28 while being backwards compatible with SFP interfaces. NGSFP-DD is the next generation small form factor pluggable with double density. Although the outer dimensions are smaller than SFP-DD, NGSFP-DD can provide double data rate compared to SFP-DD.

YOUR ADVANTAGES

- SFP: 28Gbps NRZ and 56Gbps PAM4 per differential pair
- DSFP / NGSFP: 56Gbps NRZ and 112Gbps PAM-4 per differential pair
- 2 x 112G/ch - Same dimensions as SFP but 2 channels, up to 200GbE per slot
- NGSFP-DD: PAM4 400G (112G x 4ch), mating compatible to SFP&DSFP modules





Y-MFC MINI-FAKRA | FAKRA | HSD

The Y-MFC series from Yamaichi Electronics meets the automotive industry's demand for powerful and fast I/O interfaces that also offer potential for cost and weight savings.

YOUR ADVANTAGES

- Developed and tested for automotive applications
- High-speed performance
- Space- and weight-saving design
- Various colour and mechanical codings available



Y-HDE - HIGH-SPEED DATA ETHERNET

With the Y-HDE series, Yamaichi Electronics offers differential high-speed connectors for the automotive sector - suitable for confined installation spaces.

YOUR ADVANTAGES

- 7 different codings of the single-type version
- Data transmission up to 20Gbps
- Space and weight-saving design
- Tested and produced for automotive applications



Y-CMC - CAMERA MODULE CONNECTOR

Cameras have become an indispensable standard in the automotive sector. With the Y-CMC series, Yamaichi Electronics offers a solution with PCB connectors and matching mating connectors.

The Fakra mating face of the counter connector offers a standard interface; other interfaces such as Minifakra are also possible.

YOUR ADVANTAGES

- Space-saving design
- Tolerance compensation
- IP69K - splash water protected
- High-speed function



Y-CCC CAR COMPUTING CONNECTOR

Yamaichi Electronics is creating the future of the connectivity of car computing systems with the new Y-CCC. This backplane connector system fulfils the high requirements for data, signal and power transmission, combined with robustness and functionality.

YOUR ADVANTAGES

- 56 signal contacts
- 48 differential pairs for High-Speed transmission up to PCIe 4.0
- 8 power pins up to 20A
- THR soldering version
- Screwing fixation of the backplane connector



Y-QUAD CONNECTION BOXES

Y-Quad is the connector series based on Quadlock connector systems. The improved design ensures a space-saving and easy to assemble product. Other versions with reduced number of pins, with/without shielding or with/without PCB as well as reflow solderable are available on request.

YOUR ADVANTAGES

- Space-saving design in regards to connector size and PCB layout
- Different pin counts on request
- Version for wave soldering or reflow soldering (pin & paste)



MODULAR JACKS | USB | HDMI, D-SUB & DISPLAY PORT

Yamaichi Electronics offers a comprehensive portfolio of all common I/O standard interfaces, both on the cable and connector side. Both market-known standard solutions and customised solutions are available on request. The I/O portfolio includes the latest products for digital sound and image transmission such as HDMI and Display Port connectors as well as the latest standards for data, signal and power transmission such as USB-C.

YOUR ADVANTAGES

- Broad product portfolio for applications in different markets
- Connectors for all relevant standard interfaces
- Customised I/O connector solutions available
- Customised cable assemblies available





SIM/MICRO SIM | SD/MICRO SD CARD CONNECTORS

Yamaichi Electronics offers a wide range of state-of-the-art card connectors for almost all SIM and SD cards in various formats. All product types support the latest flash memory card standards.

The wide variety includes various technical features, such as locking technologies from Push/Push, Push/Lock to tray type or optionally equipped with a card presence switch. A special feature is the distinctive contact design for the SIM and SD cards, which also allows vibration and shock resistance even for applications in the automotive or industrial sector.

Connectors for Compact Flash card applications are also available on request.



YOUR ADVANTAGES

- Yamaichi offers the right card connector for all common card formats
- Various unlocking techniques such as Push/Push, Push/Lock or Tray Type
- Special contact design to ensure proper function with high vibration and shock requirements

PRODUCTIONS SOCKETS

Sockets are available in various grid sizes, pin counts and arrays in through-hole technology as well as in customer-specific mounting.

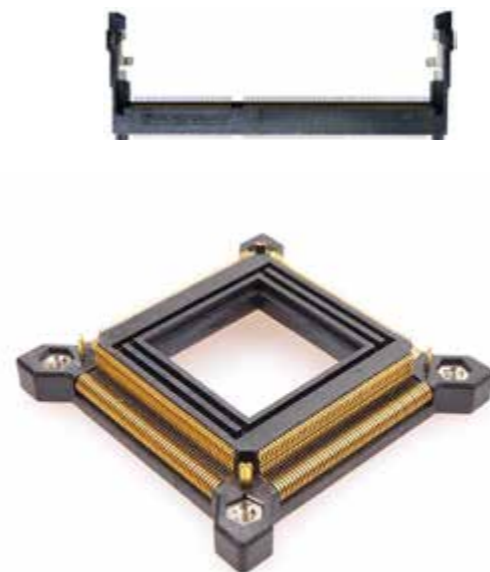

YOUR ADVANTAGES

- Yamaichi offers a wide variety of sockets for the common standards such as SO-DIMM, QFP, TQFP, BQFP, PLCC, SOP, PGA, SPGA.



CUSTOMISED SOLUTIONS

From the initial idea to series production of complex products - we take on the design and project management for the development of the perfect solution according to individual customer requirements. We offer the holistic development of customer-specific solutions, such as the development of connectors, connector systems and cable assemblies. Comprehensive product qualifications are planned and carried out in our in-house laboratories. Assembly and production take place in our own production facility in Frankfurt (Oder) or we can rely on our worldwide network of partners. The direct communication paths between sales, product management and production guarantee short response times and fast solutions for the European market.



HOT-MELT TECHNOLOGY - Y-HMT

The low-pressure injection moulding process HOT-MELT enables the gentle coating of sensitive electronic components. Due to the resistance to high temperatures, moisture, oils or disinfectants of the used plastics, the HOT-MELT process is interesting for components which have to be protected against damaging environmental influences e.g. in the automotive or medical technology. The high flexibility and comparatively low tooling costs of the process also make it attractive for small series and prototype construction.

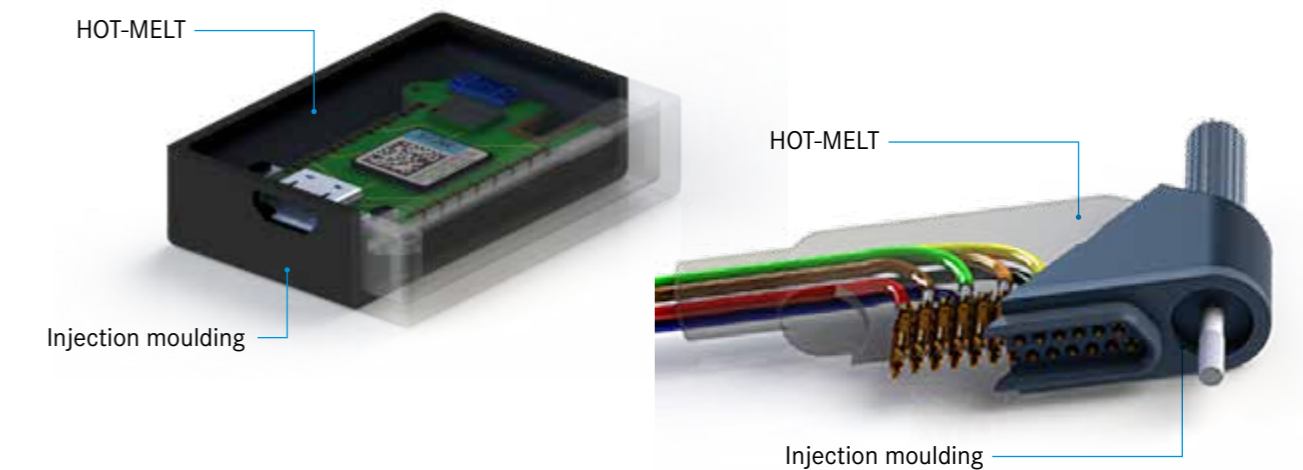

YOUR ADVANTAGES

- Low-pressure injection moulding process for highly sensitive components
- Suitable for small series
- Ideal for prototype construction
- Low tooling costs
- High flexibility

TEST AND BURN-IN SOCKETS

Support all devices on market

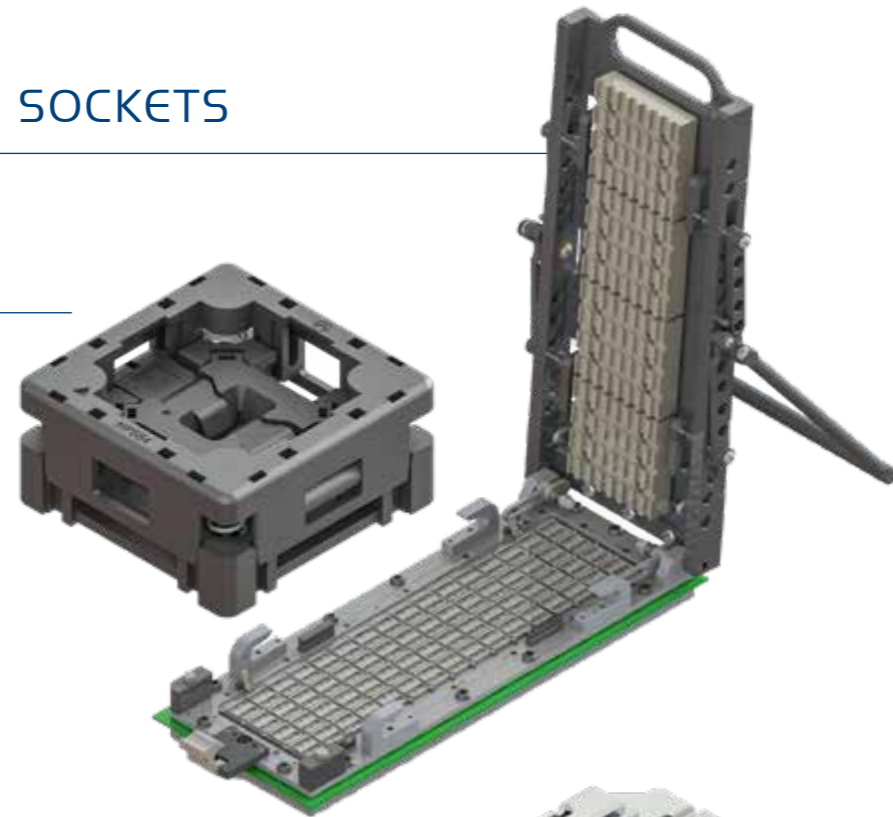

Thermal controlled (active and passive)



Test Contactors



YOUR ADVANTAGES

- Reliable contacting solutions
- For devices with a pitch of 0.25mm or more
- Robust design for ATE reliability testing and failure analysis
- Large selection of available products
- Customised designs

Y-RED – THE NEW GENERATION

In order to meet market and customer requirements, the next Y-RED generation has been completely redeveloped. Besides spring loaded pusher and socket stand-off for placing components on the PCB top side, the socket comes with a mounting plate. The mounting plate, which can be upgraded to a stiffener, is already pre-assembled with screws. This enables quick and easy assembly onto the PCB.

SMART ASSEMBLY

- Mounting plate is pressed onto PCB backside
- Socket is screwed with sleeve nuts from top side

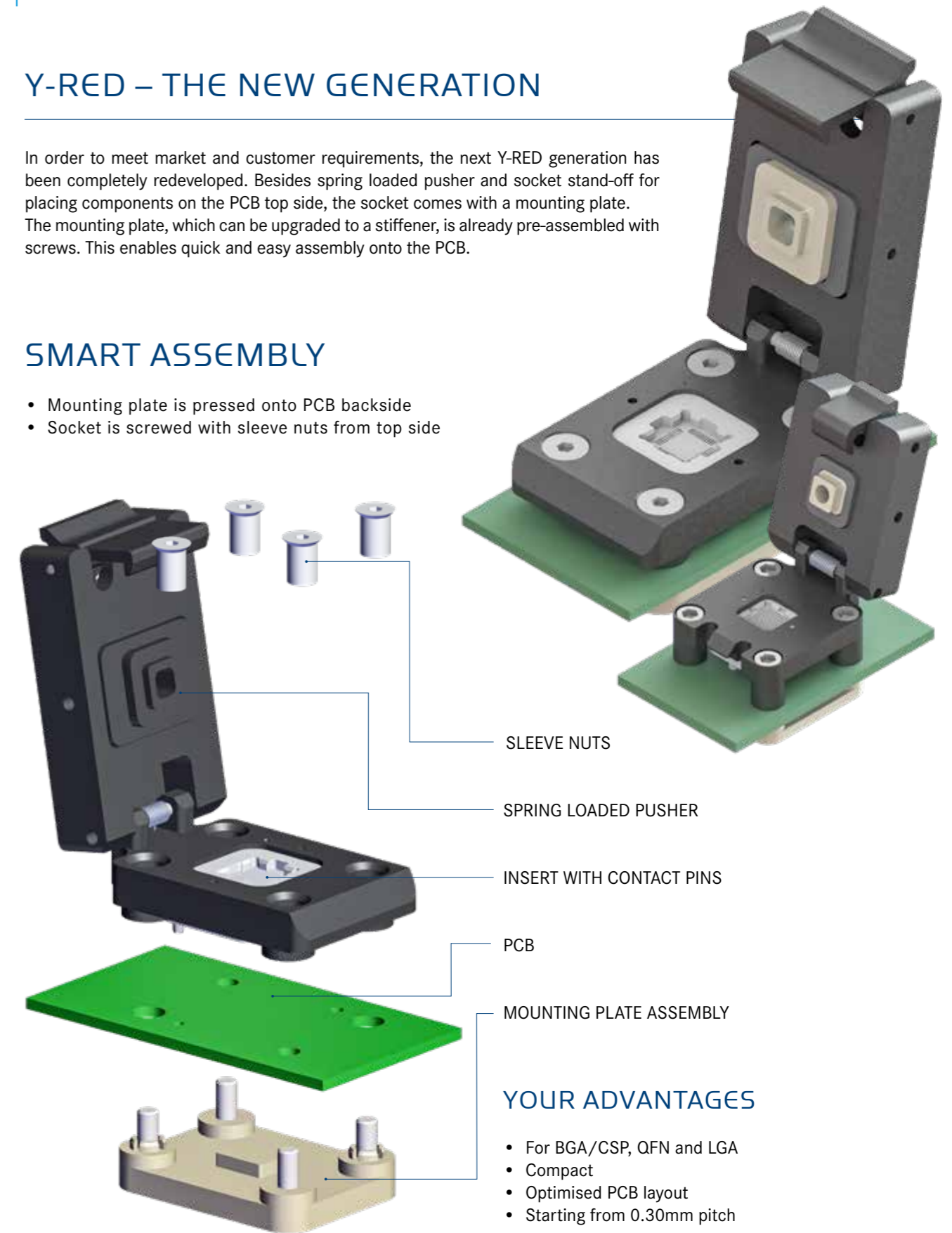

YOUR ADVANTAGES

- For BGA/CSP, QFN and LGA
- Compact
- Optimised PCB layout
- Starting from 0.30mm pitch



Y-ETI – THE NEW DIMENSION OF TESTING

The innovative Y-ETI test fixture from Yamaichi Electronics is designed for maximum flexibility in testing electronic assemblies. It enables the contacting of standard applications from low signal quality and larger test pitch to high-performance embedded solutions with test pitch starting from $\geq 0.25\text{mm}$.

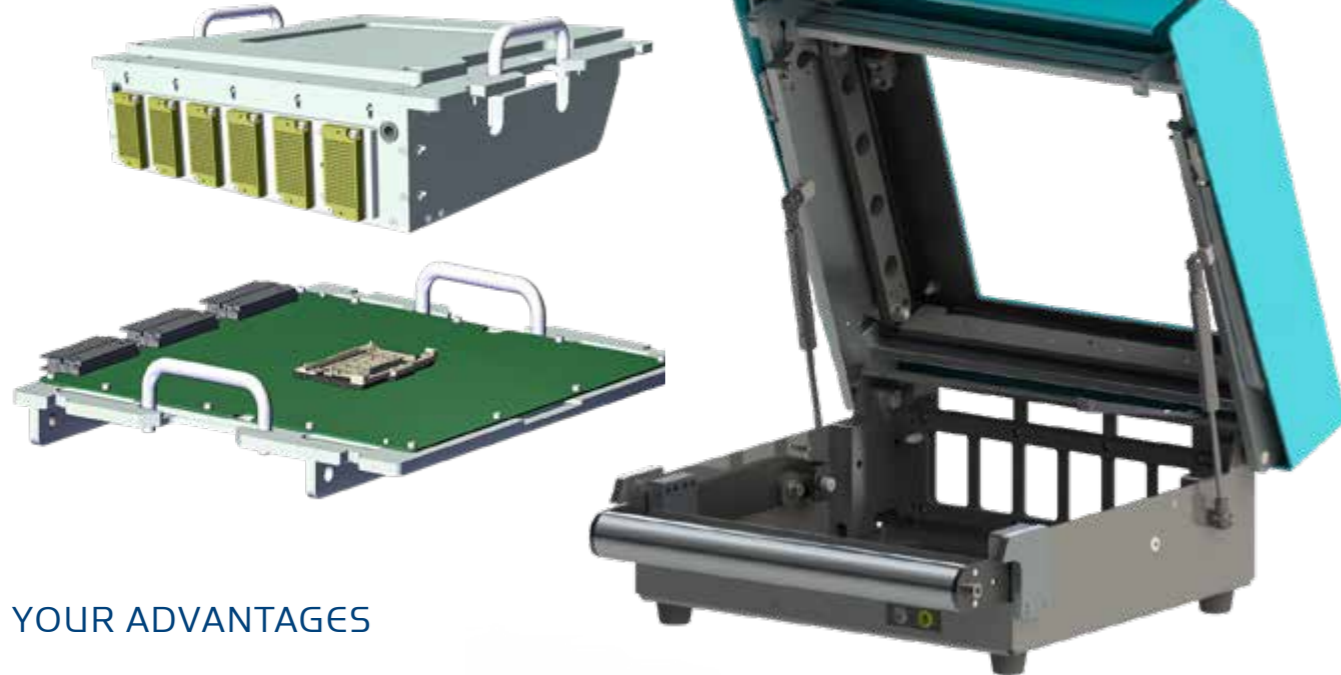

YOUR ADVANTAGES

- **Universal:** One test adapter for various test system configurations
- **Scalable:** For fine pitch from 0.25mm up to standard test pad distances
- **Optimised:** High signal quality and reliability from the device under test (DUT) to the test system
- **Individual:** Configuration of the test setup either using cassette or Test Application Board (TAB)

SPRING PROBE PINS

The pins for test contactors and test adapters start at a pitch of 0.25mm. To overcome the market needs in testing assembled PCBs, Yamaichi Electronics provides spring probes for in-circuit test (ICT) with pitches of 2.54mm with a large portfolio of various plunger tips.



COM TEST ADAPTER

Industrial Test Adapter: SODIMM, DIMM, Qseven, SMARC

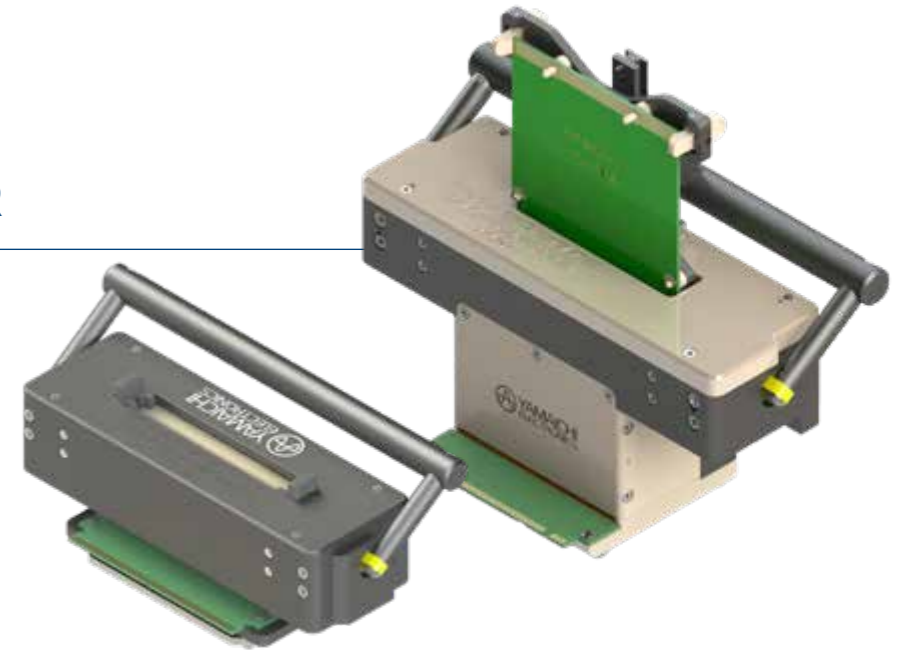

AUTOMOTIVE TEST ADAPTER

Flashing System



Board Level Testing (BLT)



System Level Test (SLT)



FPC / FFC TEST FIXTURE

YOUR ADVANTAGES

- Maximum yield in testing and flashing
- Reduced testing effort
- Less testing costs per module
- In-line volume test
- Impedance control

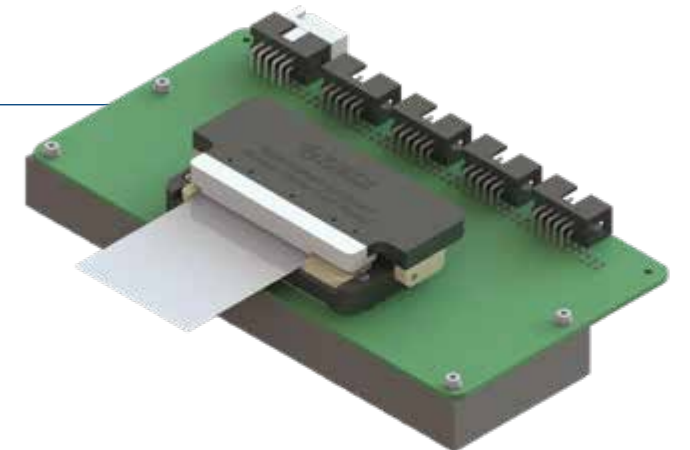



PCB SOLUTIONS

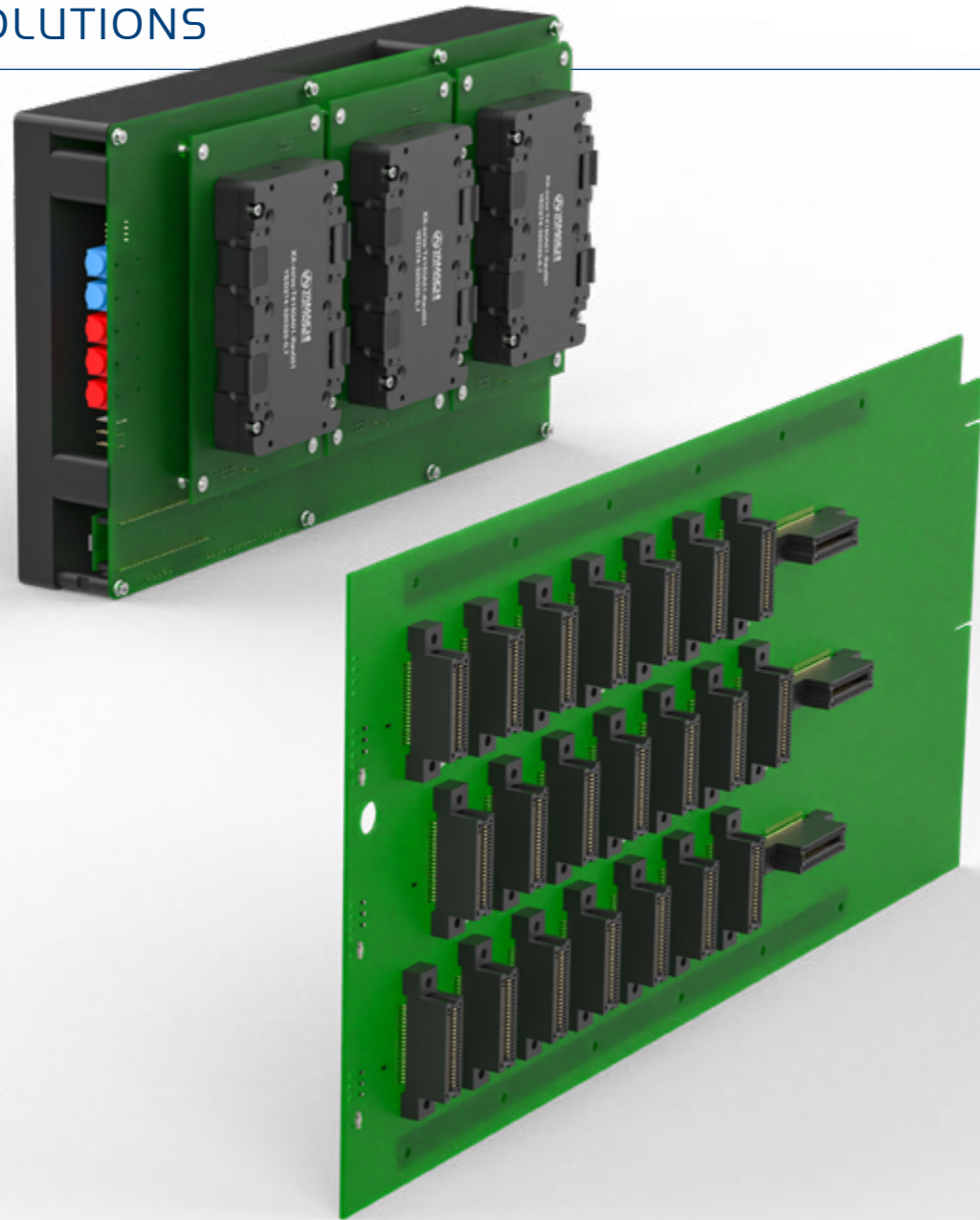

YOUR ADVANTAGES

- Customised designs for PCB and hardware
- Electrical and thermal in-house simulations
- Manufacturing & assembly with selected partners
- Consulting services



HI-REL APPLICATIONS

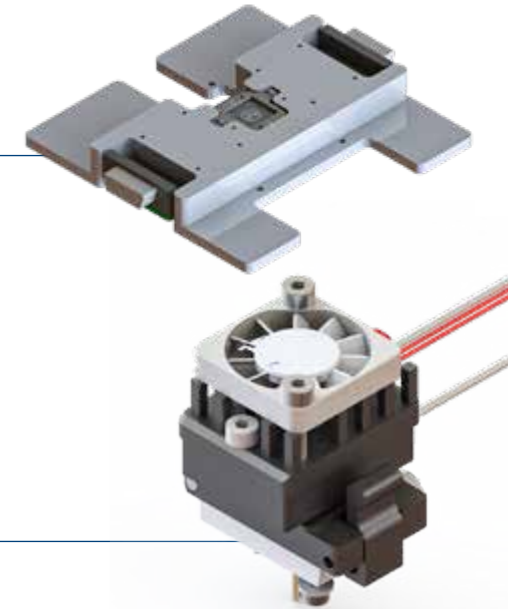

SENSING FLUIDS OF BIOSENSORS

IMAGING SENSORS/CAMERAS

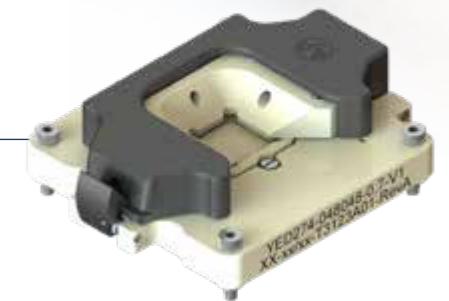

MULTI-CAVITY SOCKET (PRESSURE SENSOR)



DOCKINGS

YOUR ADVANTAGES

- Fully customised to customer requirements
- Selected materials and proven contact technology
- Reliable and robust design
- Precise manufacturing and high quality standard

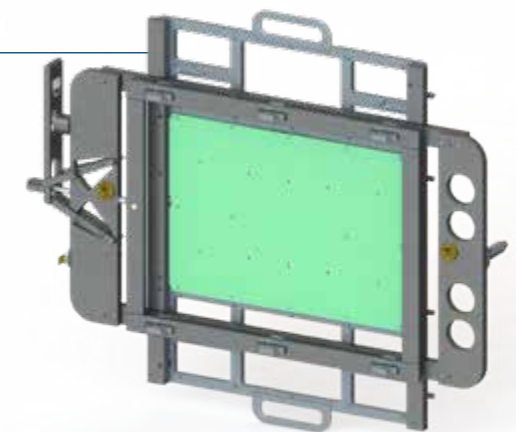



EUROPEAN PRODUCT GUIDE

CONNECTOR SOLUTIONS
TEST SOLUTIONS

YED-V1-2|4

TECHNICAL DATA ARE SUBJECT TO ALTERATION WITHOUT PRIOR NOTICE

YAMAICHI ELECTRONICS
Deutschland GmbH
Concor Park
Bahnhofstraße 20
85609 Aschheim-Dornach
Germany

Phone +49 (0)89 45 109-0
E-Mail sales@yamaichi.de
Web www.yamaichi.de

YAMAICHI ELECTRONICS
Italia s.r.l.
Centro Direzionale Colleoni
Via Colleoni, 1
Palazzo Taurus Ing. 1
20864 Agrate Brianza (MB)
Italy

Phone +39 039 6881-185
E-Mail sales@yamaichi.it
Web www.yamaichi.it

YAMAICHI ELECTRONICS
GB Ltd.
6 The Clockhouse
Stratton Park
Micheldever
Hampshire SO21 3DP
Great Britain

Phone +44 (0)7808 493377
E-Mail sales@yamaichi.co.uk
Web www.yamaichi.co.uk

YAMAICHI ELECTRONICS
Israel

P.O. # 66
Palmachim 7689000
Israel

Phone +972 54 20444 23
E-Mail sales@yamaichi.co.il
Web www.yamaichi.co.il